

3 Proposed Development

3.1 Introduction

This section of the EIAR describes the proposed development as it will be following completion of all construction activities. A full description of the construction of the proposed development is presented in **Chapter 4 Construction Strategy**. Construction compounds, temporary construction installations and all facilities, required for the construction phase, are also described in **Chapter 4**.

This chapter has been prepared by Simon Grennan and Dan Garvey of Arup based on information supplied by GIL and its consultant, WSP, for the electrical elements, and Arup's civil engineers for the civil engineering elements. A description of the authors' qualifications and experience is presented in **Appendix 1.1**.

3.2 Overview

The proposed development (encompassing the onshore elements in Ireland only) will comprise:

- **Landfall Compound** - a temporary landfall compound at Baginbun, where the high voltage direct current (HVDC) cable will be installed underground, below the beach and cliff at Baginbun Beach, by horizontal directional drilling (HDD);
- **HVDC Cables** - two HVDC electricity cables with a nominal capacity of 500 megawatts (MW), installed underground from the landfall at Baginbun to the converter station, including jointing bays and ground level marker posts at intervals along the route;
- **Converter Station** - a converter station situated close to the existing Eirgrid 220kV Great Island substation in Wexford;
- **Tail Station**- A 220kV Loughtown substation located beside the converter station. The tail station connects the HVAC 220kV cable into the 220kV grid via the existing Eirgrid Great Island substation.
- **Converter Station Construction Compound**: temporary compound for the construction of the converter station and tail station at Great Island.
- **Cable Contractor Compounds** - three temporary cable contractor compounds will be required (i) at the landfall site close to Baginbun Beach (ii) at the proposed converter station and (iii) one along the onshore route in the townland of Lewistown;
- **HDD Compounds** - temporary HDD contractor compounds are required. One will be located close to the cable contractor compound at Baginbun Beach with another HDD compound located at either side of the Campile River Estuary crossing;

- **High Voltage Alternating Current (HVAC) Cables** - one 220 kV HVAC electricity cable circuit consisting of three cables, installed underground connecting the converter station via the Loughtown tail station to the existing EirGrid substation;
- **Fibre Optic Cables** - fibre optic cables for operation and control purposes, laid underground with the HVDC and HVAC cables;
- **Community Gain Roadside Car Parking near Baginbun Beach** - in consultation with Wexford County Council, circa 54 roadside car parking spaces will be constructed; and
- **Community Gain in Ramsgrange Village** - in consultation with Wexford County Council, extension to existing footpaths, four new street lights and a speed activated sign at Ramsgrange.

An overview of the proposed development (in the context of the overall Greenlink project) is presented in **Figure 1.3**. Further details on the various onshore elements in Ireland are presented in this chapter.

Note that the design and configuration of underground HVAC and HVDC cables are different. HVDC cables transmit power using direct current and HVAC cables transmit power using alternating current.

3.3 Land Requirements

3.3.1 Wayleave, Working Width and Deviation Allowance

GIL will have a permanent wayleave along the route of the HVDC and HVAC cable to allow access for future maintenance. Where the cable is routed across agricultural land (off the public road), the width of the permanent wayleave, which has been agreed with the landowners is 15m and the agreed temporary working width is 30m (centred on the permanent wayleave width). The cable will generally be routed along the centreline of the permanent wayleave. The 30m temporary working width will give sufficient area for the excavation of the trench, storage of topsoil and subsoil arisings plus a haul road for the movement of the excavation equipment and general installation vehicles for the delivery of materials such as ducting, protective covers and bedding. existing roads or lanes, the permanent wayleave will generally be the width of the road or lane. The temporary working width for cable construction will depend on the width of the road or lane. Where feasible, if the road or lane is wide enough, one carriageway will remain open to traffic.

The proposed cable centreline is shown on the planning drawings. In the unlikely event of unforeseen circumstances arising during construction, it may be necessary for the cable to deviate from the centreline position, and the cable may be positioned anywhere within the redline boundary shown on the planning drawings.

Within the permanent wayleave where it crosses farmland, the wayleave agreement allows the planting of crops and shallow rooted plants, to facilitate ongoing agricultural use. Planting of deep-rooted plants or construction of buildings is excluded.

3.3.2 Land Acquisition

The sites for the converter station and tail station will be permanently acquired for the purposes of the proposed development. Wayleave agreements over land have been made with the relevant landowners. The wayleave agreements provide sufficient legal interest for the consent applications to be made and for the proposed development to be constructed.

3.4 Cable Routes

3.4.1 HVAC Grid Connection

The HVAC grid connection will be made from the Great Island 220kV substation, to the proposed Great Island converter station, via the proposed 220kV Loughtown tail station.

The connection from the tail station will be made into an existing spare bay in the Great Island 220kV substation. No extension of the 220kV switchgear is required. No deep reinforcement is required to the 220kV transmission grid, of which the Great Island substation is a node, to facility the Greenlink converter connection. Refer to **Sections 3.5 and 3.6**, below for descriptions of the tail station and converter station.

3.4.2 HVAC Cable Route

The converter station, tail station and Great Island substation are adjacent to each other and the connection will be made by an underground 220kV cable.

From the Loughtown tail station, the cable will be laid in a southerly direction before crossing westwards into the SSE landholding at the southern edge of an existing car park. Once in the SSE landholding, the cable will be laid under the Gas Networks Ireland high pressure gas pipeline which serves the Great Island Power Station. At the western side of the car park, the cable will be laid in an existing site road in a southerly direction for a short distance along this road, then turn westward and then northwards, entering the EirGrid Great Island substation from the south.

The HVAC cable route will be approximately 420 metres long and is shown (as an orange line) on **Figure 3.1**.

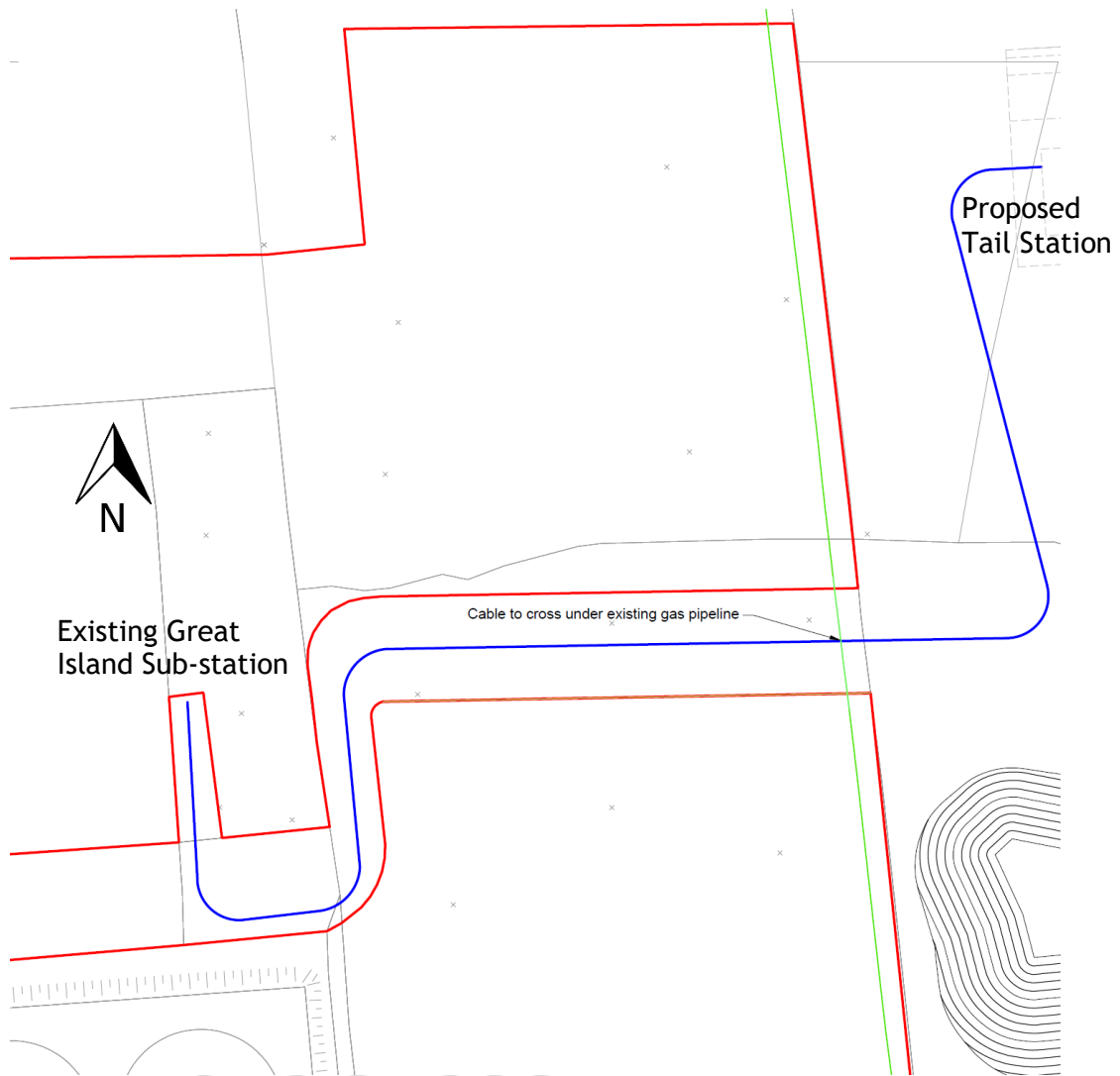

Figure 3.1: HVAC Cable Route (blue line) | not to scale

3.4.3 HVDC Cable Route Description

The cable route between the converter station and the landfall site is approximately 23km long. The entire route will be underground.

The onshore cables are routed along local roads, apart from the portions of the route closest to the landfall location, the converter station, and where it is necessary to divert the route off the road for engineering reasons, as described below. The cable route is shown in **Figures 3.2 to 3.8** and is described in more detail below.

Converter Station to R733

From the converter station, the cables will be laid cross-country, off-road, in a north easterly and then southeasterly direction through agricultural land (pasture and tillage) for the first circa 2.7 km before meeting the R733 to the west of Campile just south of Dunbrody bridge. Construction access to this off-road section will from the local road, in the townland of Kilmannock, a short distance to the north of the junction of the local road with the R733.

This section of the route includes a trenchless crossing of the Campile River Estuary, downstream of Dunbrody Bridge. The cables will be a minimum of ten metres below the river bed at this location.

The width of the planning corridor along this section of cable route varies to give some flexibility for cable alignment. In the location of the estuary crossing for example, the planning corridor is up to circa 300 m in width, to provide the flexibility needed for the trenchless crossing and the HDD construction compound. For construction purposes, in farmland, a 30m working strip of land will be fenced-off to enable construction. This is described in more detail in **Chapter 4 Construction Strategy**.

Along this section of the route, there are existing services which cross the cable route, including telecoms and overhead medium voltage (MV) electrical lines.

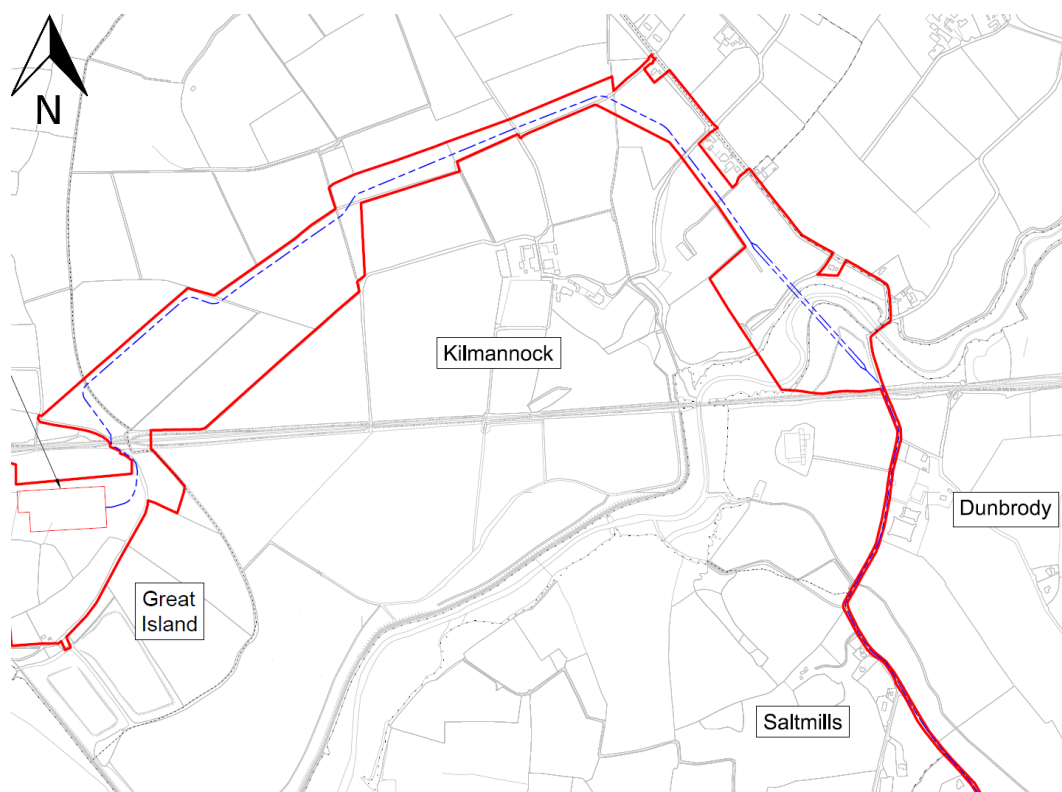

Figure 3.2 HVDC Cable Route (Figure 1 of 7) | not to scale

R733 to L4050

Just south of the Campile River Estuary crossing, the cable will be laid in the R733 road where the road passes under a bridge carrying the disused Waterford to Rosslare railway. The cable route travels southwards along the R733 for a distance of circa 5 km, passing through the townlands of Dunbrody, Saltmills and Grange. Along this length, the cable will be laid within the road or verge, depending on the final alignment and existing services.

This section of cable route is along a roadway which passes primarily through farmland, with a few farmhouses along the route. The route also passes the Dunbrody Abbey Visitor centre, at the northern end of this section of the route.

The cable route crosses existing services along this section of the route, including watermains, telecoms and overhead electrical lines.

At the junction of the R733 and the L4050, the cable route leaves the R733 road continuing southwards on the L4050 road. There is some ribbon development at this junction, along both sides of the road.

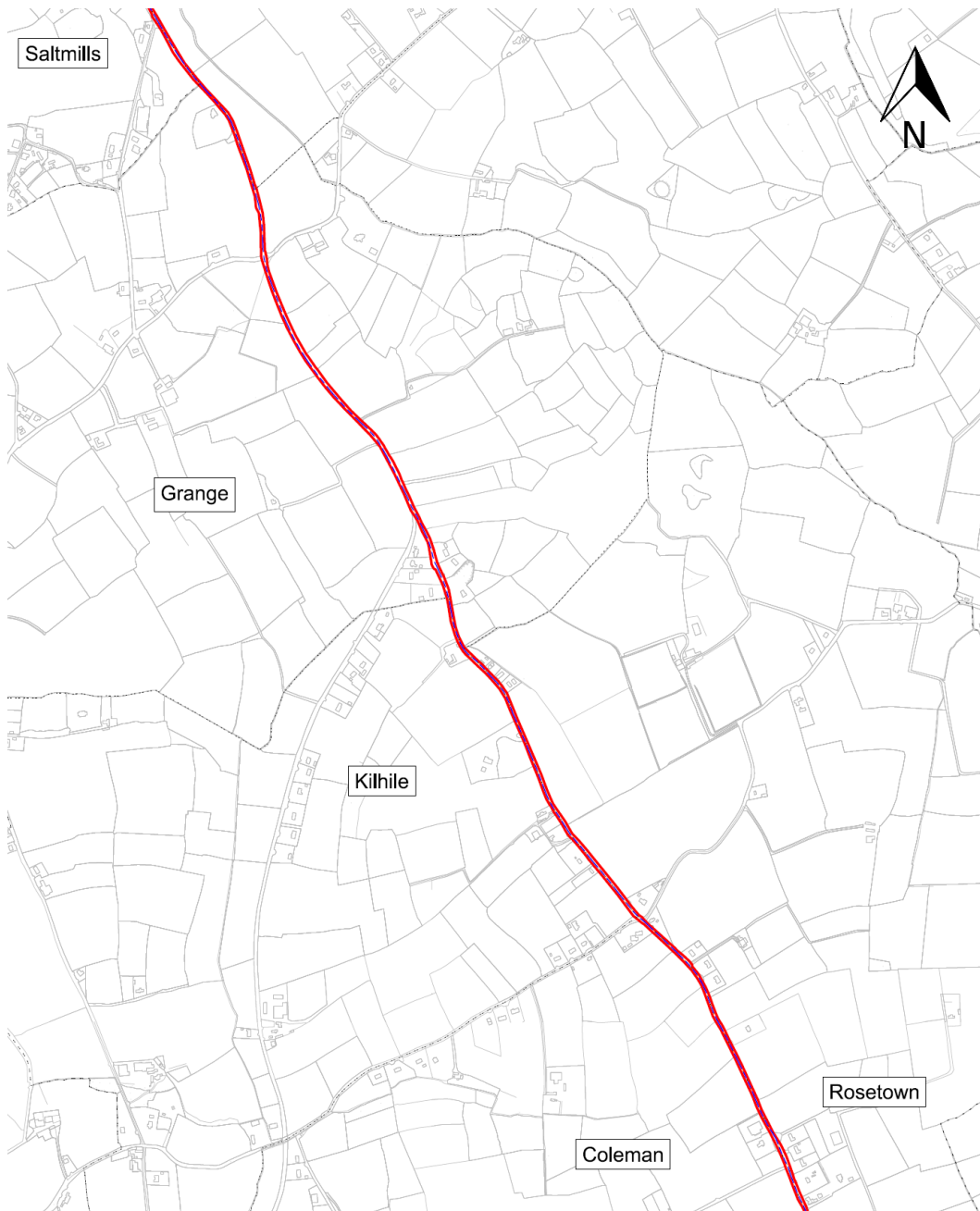

Figure 3.3 HVDC Cable Route (Figure 2 of 7) | not to scale

L4050 to R733 (at Suttons Cross)

The cable route follows the L4050 road generally in a southerly direction, for circa 2.8km, passing through the townlands of Kilhile, Rosetown and Coleman. There is a higher level of ribbon development along the road through this section of the cable route, with associated services crossing the cable route and laid within the roadway.

These services include, in particular, telecoms and watermains, as well as overhead lines, which cross the cable route in a number of locations. The final position of the cable within the roadway, will be dependent on the exact location of these services.

At Suttons Cross, the cable route joins the R733 once more, turning in an easterly direction towards Ramsgrange.

At Suttons Cross, the route turns through a circa ninety-degree bend. The wayleave/planning boundary will be widened on both sides of the road to give flexibility for the cable alignment at the bend, and to minimise impacts on existing services (there is a watermain on the southern side of the road and telecoms on the northern side of the road) in this location.

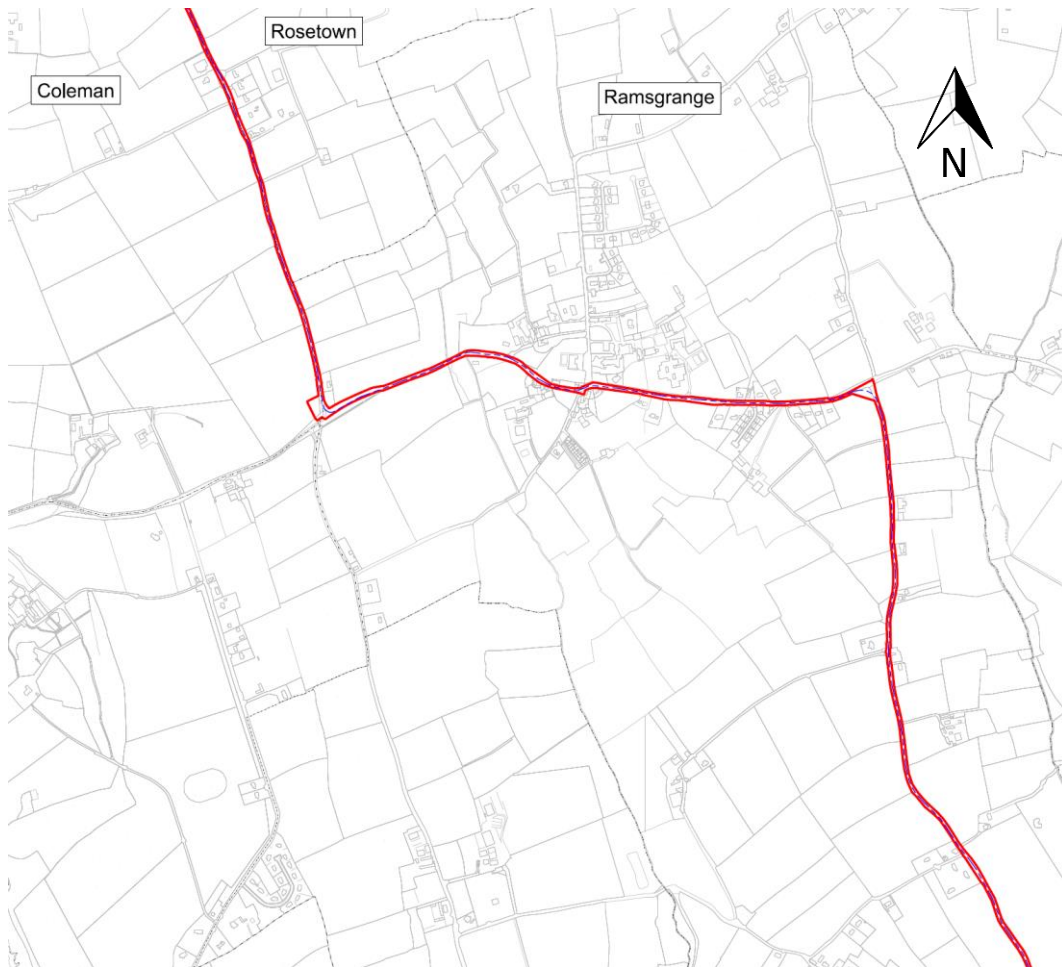

Figure 3.4 HVDC Cable Route (Figure 3 of 7) | not to scale

R733 to the Templar's Inn (Templetown)

From Suttons Cross, the cable will follow the R733 in a generally easterly direction, through the village of Ramsgrange, until it meets the L4045, a distance of circa 1.5km. The cable will be laid generally within the roadway along this section, with existing services encountered at various locations and running parallel with the cable, particularly through the village. The services include telecoms, watermains and overhead electrical lines.

At the junction with the L4045, the route turns through a circa ninety-degree bend. The cable will be laid outside the roadway, to the southeast, in farmland, and the wayleave/planning boundary will be wider in this location to accommodate the bend in the alignment. This alignment also avoids the services within the road at this junction.

The cable will then turn south, travelling along the L4045 over a distance of circa 7.5km, through the townlands of Ramsgrange, Kilbride, Ballinruan, Aldridge and Booley to Lewistown, where a temporary construction compound will be located. The construction compound will be to the north of the cable route, a short distance off the L4045. The Lewistown temporary construction compound will accommodate site offices, welfare facilities, parking and materials storage for the cable contractor. The compound is described in **Chapter 4, Construction Strategy**. The compound will be in a field, currently in pasture, with forestry on the eastern boundary of the compound, an area of scrubland to the south and a farm holding to the north. A temporary short access road will be constructed from the L4045 to the compound.

DRAFT

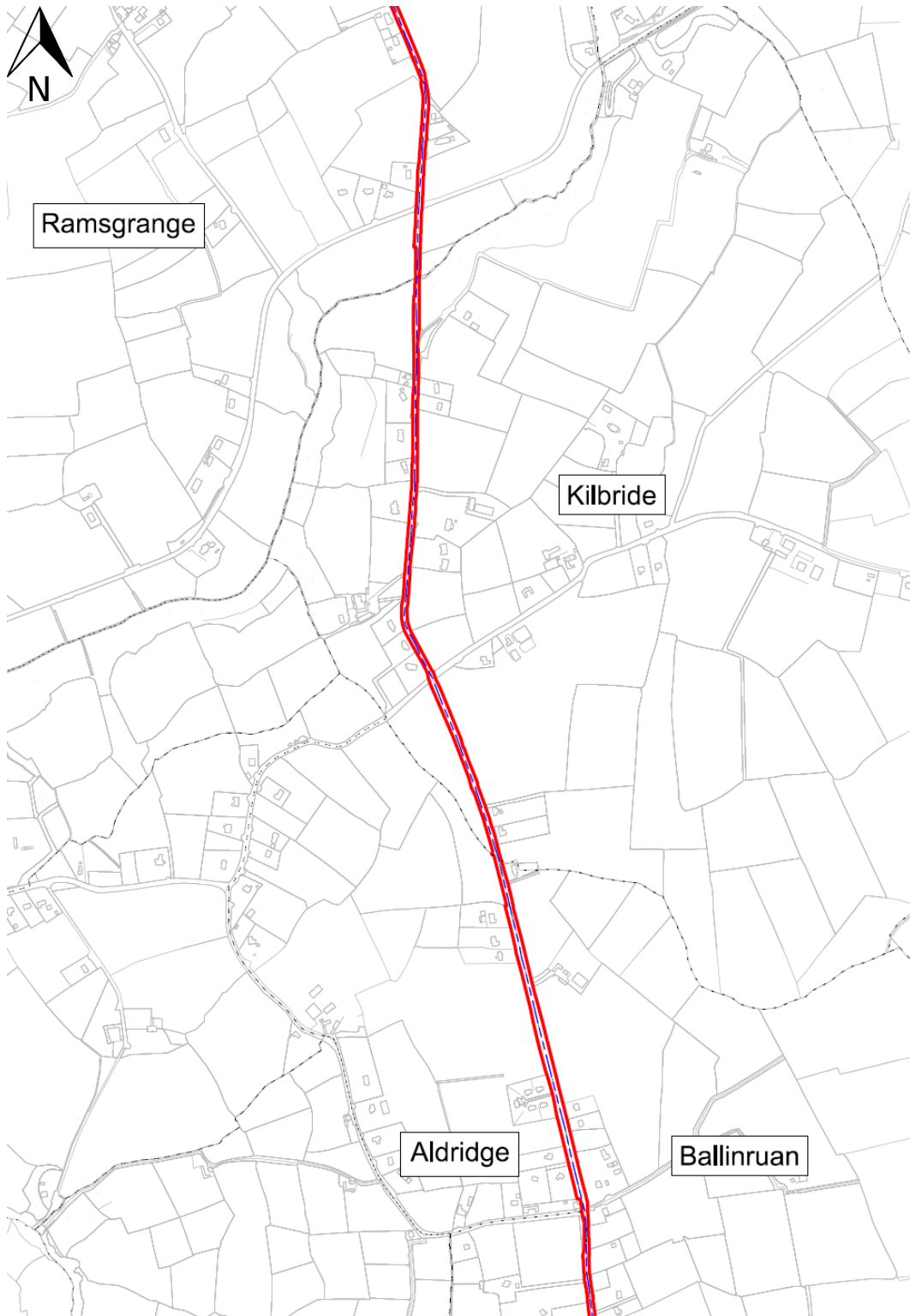

Figure 3.5 HVDC Cable Route (Figure 4 of 7) | not to scale

From Lewistown construction compound access road, the route continues southwards on the L4045 through the townland of Kilcloggan to the junction with an unnamed local road at the Templar’s Inn, in the townland of Templetown.

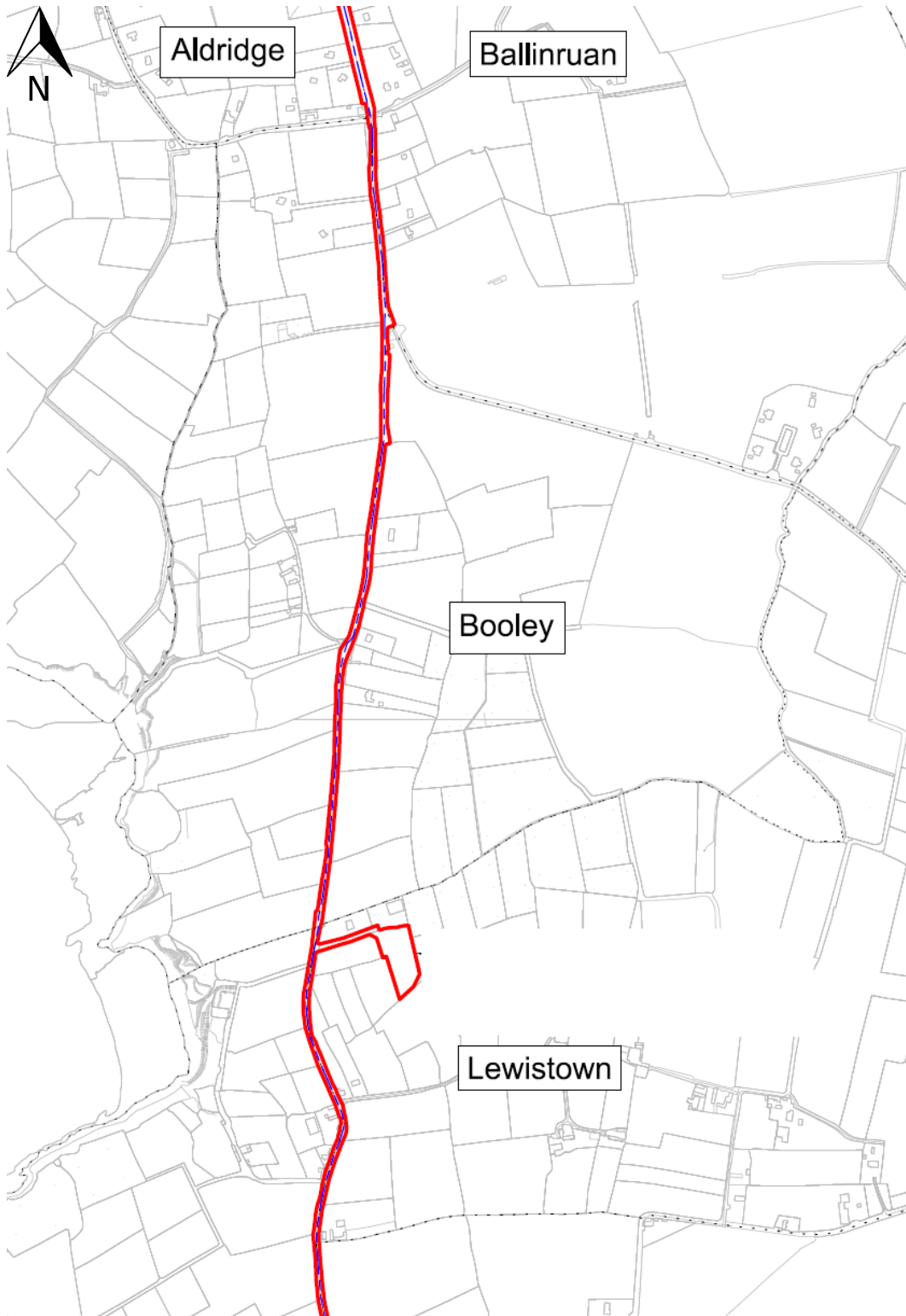

Figure 3.6 HVDC Cable Route (Figure 5 of 7) | not to scale

Most of the ribbon development along this section of the route is on the northerly section, nearer Ramsgrange and at the southern end, near the coast, with the middle section being mainly surrounded by farmland.

There are existing services both crossing and along the proposed cable route, with watermains in particular laid within the roadway for most of this route section.

At the junction of the L4045 and the unnamed local road at the Templar's Inn, the cable route turns to the east through a circa ninety-degree bend. The wayleave will be widened to the west and the cable will be laid in farmland to the west of the road at this junction, to achieve the required alignment and avoid existing services.

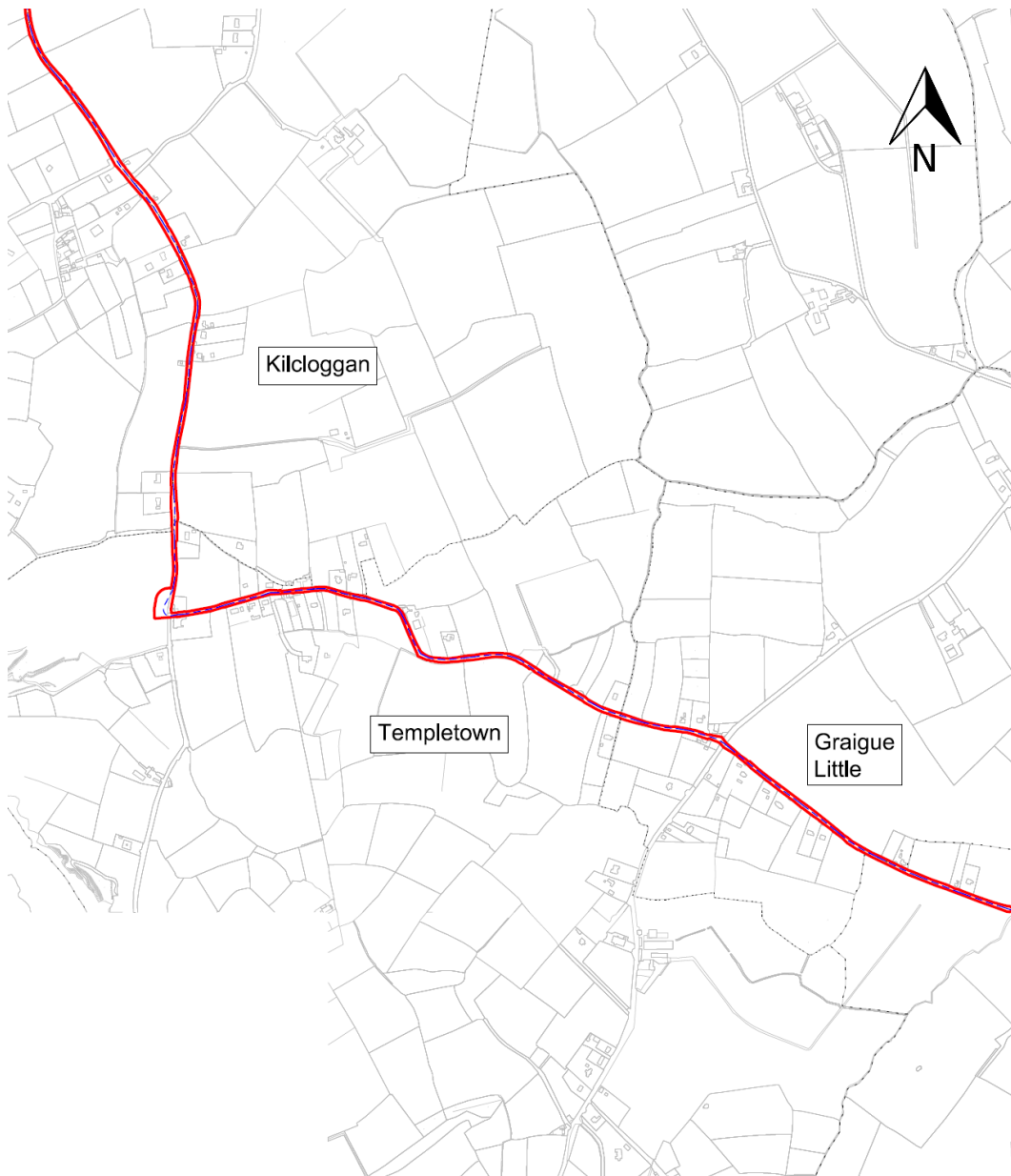

Figure 3.7 HVDC Cable Route (Figure 6 of 7) | not to scale

The Templar's Inn (Templetown) to Landfall

From the junction of the L4045 and the unnamed local road at the Templar's Inn (Templetown), the cable route again follows the road in a southeasterly direction for circa 2.1km, through the townland of Graigue Little to the townland of Graigue Great.

There are two bends in close succession in this narrow road at Graigue Great. The route leaves the road for a distance of circa 250m to accommodate the two bends. The wayleave will be widened and the cable will be laid in farmland north of the road at this location. The route rejoins the road, travelling south/southeasterly for circa 300m to another bend in the narrow road. At this location the wayleave will be widened to the west and the cable will be laid farmland for circa 200m.

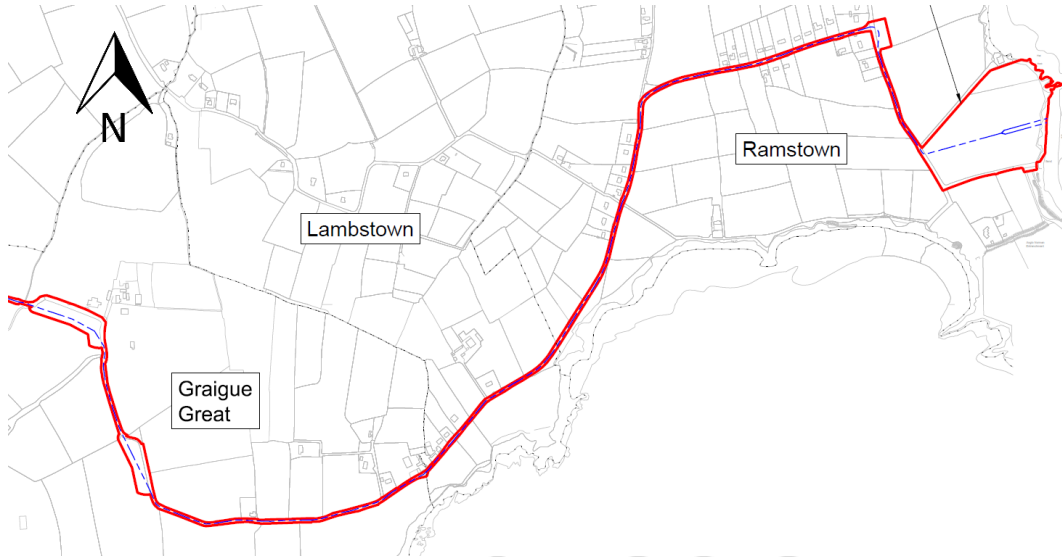

Figure 3.8 HVDC Cable Route (Figure 7 of 7) | not to scale

From this point, the cable route follows the unnamed road for circa 3km, travelling east and then northeast along this coast road, through the townland of Lambstown, before turning north through the townland of Ramstown. The route follows this road to the east, through the village of Ramstown to the junction with the L4049. At the junction with the L4049, the route turns south along the L4049, through a circa ninety-degree bend, towards the coast until it reaches the field proposed for the landfall site at Baginbun Beach. At the ninety-degree bend, the wayleave will be widened, and the cable will be laid in farmland, to accommodate the alignment.

At the landfall site, which is in farmland to the east of the road, the cable route crosses the site to the proposed landfall HDD compound.

Along this route, which is adjacent to the coast, there is ribbon development including some new development within and in proximity to the village of Ramstown.

There are also existing services crossing and along the cable route, including watermains, telecoms and overhead electrical cables. In particular, both the watermains and telecoms cables run along the roadway for a significant portion of the route.

3.4.4 Onshore Cable Technology

The nominal HVDC voltage of the onshore cables will be +320kV. The maximum continuous current will be 810A, while the maximum overload current will be 1,134A.

The HVAC cable will be 220kV rated. The maximum continuous current will be approximately 1,362A, while the maximum overload current will be approximately 1,907A.

3.4.4.1 HVDC Cables Typical Trench Detail

The two HVDC onshore cables will be buried underground in a single trench with a typical depth of cover of 850mm to 1000mm. The standard depth of burial for cables buried in agricultural land will be 1050 mm to the top of the cable ducts, refer to **Figure 3.9**.

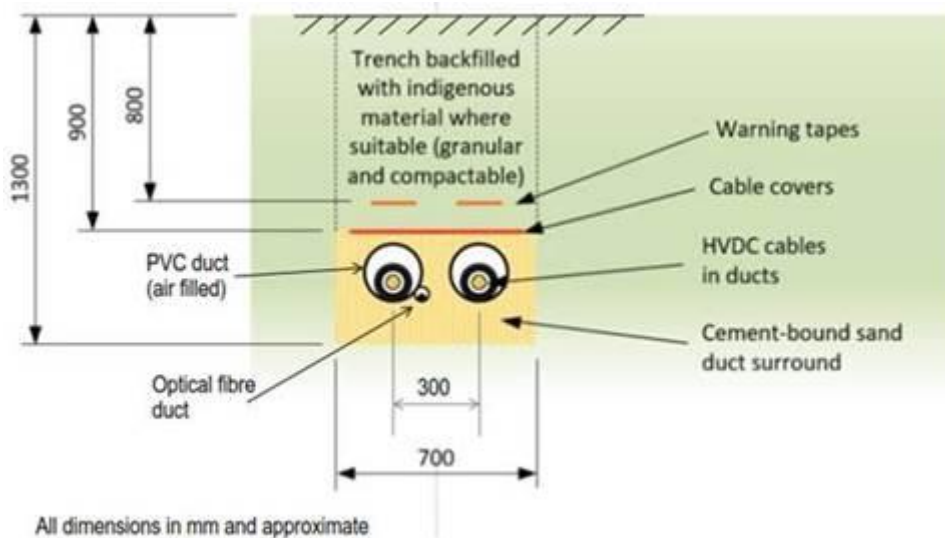

Figure 3.9 Typical HVDC Trench Cross-Section (source: WSP | not to scale)

The cables will be installed in plastic duct to simplify the construction process. It is usual for the two ducts to be positioned close together (approximately 300mm). A protective cover and warning tape are also usually buried along with marker posts at regular intervals at ground level.

3.4.4.2 Cables at Greater Depth

Where cables need to be buried at a greater depth (i.e. to avoid existing services or at a HDD), it will be necessary to increase the cable spacing to maintain the cable rating.

The cable axial spacing at various depths is dependent upon the conductor size selected. A typical depth spacing curve for an 800mm² aluminium conductor cable design is presented in **Figure 3.10**.

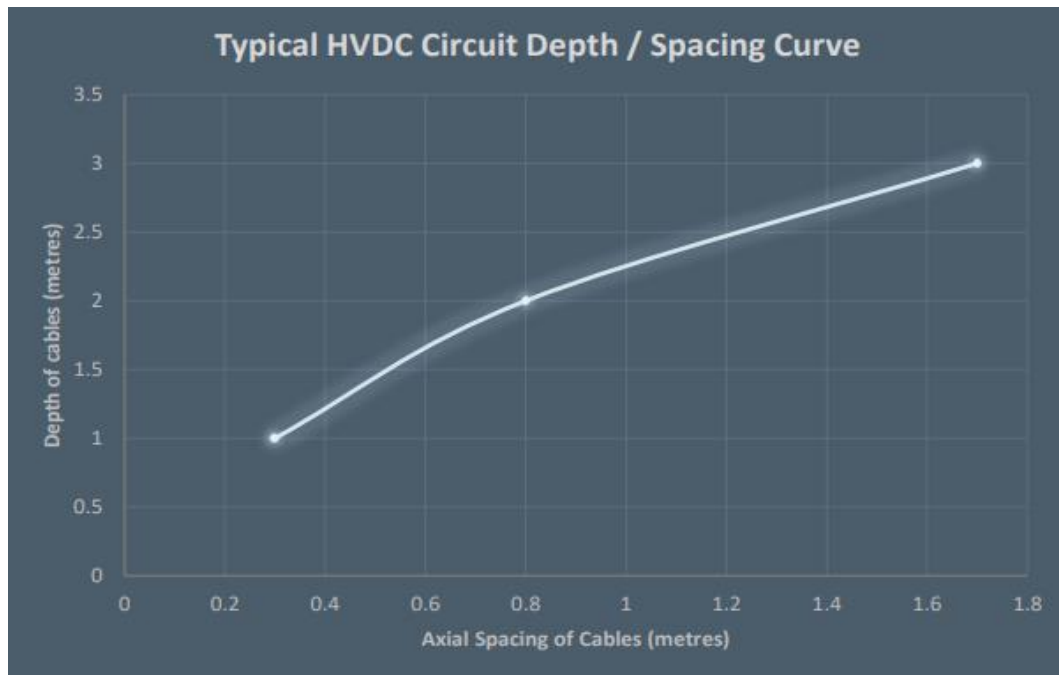

Figure 3.10 Typical HVDC Circuit Depth/Spacing Curve

For onshore cables typical burial depths for HDDs will be in the range of 5 metres to 10 metres. When cables are installed at a greater depth it will be necessary to increase the cable spacing to maintain the rating of the cables. Typically, the axial spacing between ducts will be in the range of 5 metres to 10 metres. The depth of the HDD will be dependent on the ground profile and the cable spacing will be dependent upon the cable ratings. The maximum axial spacing between HDDs will be 10 metres. At this spacing, each cable can be regarded as thermally independent.

For onshore cables the expected outer diameter of the HDD will be in the range of 200mm to 250mm. The expected outer diameter of the HDD at the sea/land interface will be in the range of 350mm to 450mm.

3.4.4.3 Cable Surround Material

For virtually the complete route the duct surround will be a granular well-compacted thermally suitable material (e.g. cement bound sand) up to the protective covers. This material will have the required thermal properties (i.e. a thermal resistivity of 1.2 Km/W) and ensure that no drying out of the indigenous soil occurs within the 50°C isotherm. For HDD locations it is not possible to have a special backfill around the cables and therefore the ducts will be installed at a greater spacing to improve heat dissipation and ensure no drying out of the indigenous soil occurs.

The trench back-fill above the protective covers will also be well compactable and thermally suitable. Most types of soil will be thermally suitable. However, ground types and material that will not be thermally suitable are as follows:

- Fuel ash;
- Made ground and rubble; and

- Peat.

The cable route will avoid areas that contain the materials listed above. The suitability of a cable route will be confirmed by trial holes, and it is considered there is sufficient scope for micro-routeing of the cables, within the permanent wayleave and red line boundary, to achieve a route through suitable material.

3.4.4.4 HVAC Cable Typical Trench Detail

220kV HVAC cables will connect the proposed converter station to the existing electricity substation. The arrangement for the underground HVAC cables is illustrated in **Figure 3.11**.

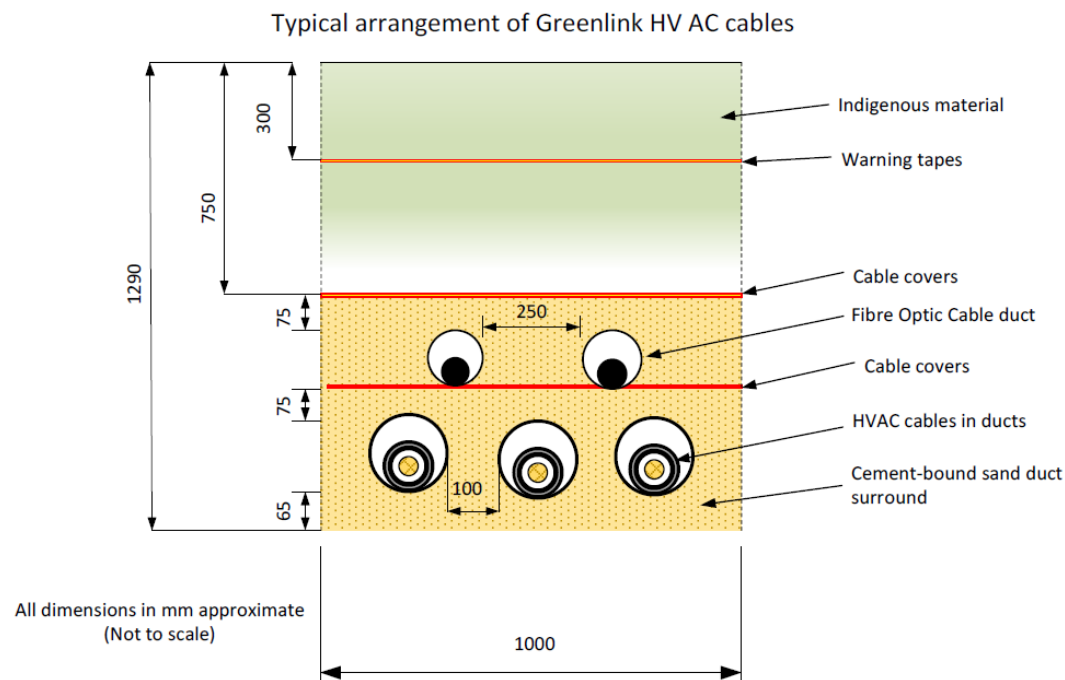

Figure 3.11 Typical HVAC Trench Cross-Section (source: WSP | not to scale)

3.4.4.5 Cable Details

XLPE insulated cables will be used for both the HVDC and HVAC circuits. The offshore and onshore cables will be different in that the subsea cable requires an armouring of steel wires helically wound around the cable for protection from the rigours of subsea installation and the subsea environment.

Ducts and Protective Measures

Both the HVAC and HVDC cables will be installed in ducts. The cable ducts will be plastic (i.e. either PVC or PE). It is anticipated that the duct will have a diameter of approximately 200mm. The depth will be increased in farmland to around 1050mm (increase from 850mm).

The width of the trench will also vary with depth of cover (the deeper the cables are buried the wider the trench may become).

The protective measures required for the cables are listed below. Some of these protective measures will not be practical at some locations (e.g. the HDD under the Campile River Estuary).

- The cables will be installed in plastic cable ducts;
- Around the cable ducts there will be a thermally suitable compactable granular material such as cement-bound sand (CBS or weak concrete mix);
- Above the cable backfill there will be cable covers for the full trench width;
- Above the protective covers there will be a warning tape;
- At joint-bays a concrete slab will be positioned at the bottom of each joint-bay;
- At jointing-bays, above the joints and the thermal backfill there will be protective covers fitted across the full joint-bay; and
- At road crossings the cable ducts will be embedded in concrete.

Marker Posts

Marker posts (refer **Figure 3.12**) will be installed with approximately 750mm of the post above ground and 600mm below ground location, and will be put in place at the following locations:

- Along railways or at railway crossings;
- At road crossings;
- Across agricultural land, in which the marker posts will be located at the edge of field where cables enter and leave the field;
- At joint locations; and
- At change of direction of the cable route.

A typical marker post is shown in **Figure 3.12**.



Figure 3.12: Typical Marker Post

Link Boxes

Link boxes will be located along the route at approximately 5km intervals. They will be located in a pit close to the joint-bay (typically less than 10m apart). There will be an earthing strip around the periphery of the joint-bays where link boxes are installed. The earthing strip is typically a copper tape, approximately 75mm² to 300mm² in size, and provides an interface to ground via joint bay earth rods. The earth strip connects the cable screen to earth via the link box.

There will be bonding leads (i.e. lower voltage cables) running from the link-boxes to the joints. **Figure 3.13** illustrates a typical link boxes. They will need to be accessed occasionally (i.e. approximately every 2 years) to allow the outer polyethylene layer of the cable to be tested for integrity.



Figure 3.13: Link box (typical dimensions: 1m long x 0.8m wide x 0.5m deep)

Fibre Optic Cable Splicing Boxes

Fibre optic cable splicing boxes (communication chambers) will be located near each joint bay **Figures 3.14** and **3.15** illustrates a typical fibre optic box.

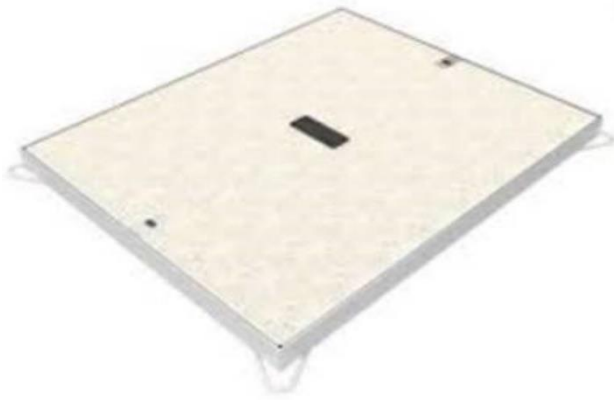

Figure 3.14: Fibre Optic Box (lid) as seen at ground level

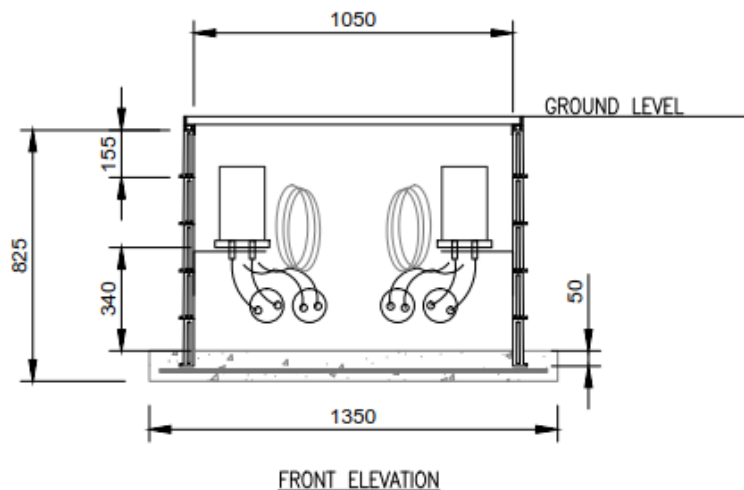

Figure 3.15: Fibre Optic Box at underground level | not to scale

Joint Bays

Typically, up to 1.8km of HVDC cable can be carried on a single reel. This results in one jointing bay being required every 1.8km of a cable installation, at a minimum. However, it is expected that joint bays will be required at circa 1km spacing, to reflect the complexity of the final cable route. Once the joint has been made the cable will be buried in the same manner as the rest of the underground cable. Further information on the location of joint bays along the route and the jointing of cables is given in **Chapter 4 Construction Strategy**.

3.4.5 Landfall Description

As described in **Section 3.4.4.5** above, the offshore cables will be to a specification which will be different from the cables to be used onshore. The connection between the onshore cables and offshore cables will be made at a location adjacent to Baginbun Beach. In a field inland from the beach, a horizontal directional drill (HDD) will be made (as described in **Chapter 4 Construction Strategy**), connecting to the offshore element of the project at a point below the low-tide mark on the seabed.

3.4.5.1 Landfall Site Description

The landfall site is shown on **Figure 3.8**. The site is located directly adjacent to the coast, to the southeast of the hamlet of Ramstown. The site comprises a large field, currently in tillage, bounded on the eastern side by Baginbun Beach, to the north by a private access to a dwelling house, to the south by a road providing access to the beach and to the west by the local public road. The site area within the redline boundary, which includes the road on the southern side, is 6.63 hectares (16.4 acres).

The site is gently undulating, with a slight northeast - southwest aligned ridge towards the centre. Ground levels vary from just less than 11.00mOD at the northeastern boundary, to almost 16mOD at the high point of the ridge.

3.4.5.2 Cable Landfall Technology

The cables to be installed on land will be different from the marine cables, as explained in **Section 3.4.4.5** above. The land cables will be connected to the marine cables in a Transition Jointing Bay (TJB) buried in the ground in the field inland from Baginbun Beach and a line of low cliffs. The TJB at the sea-land interface will contain the following:

- 2 no. armour clamps (fixed to a concrete block);
- 2 no. HVDC cables joints;
- Concrete plinth;
- A fibre joint;
- A link-box or link-pillar; and
- There will be an earthing strip around the periphery of the joint-bay.

HDD is the preferred method of installation at the landfall site inland. Further information on cable installation by HDD is provided in **Chapter 4, Construction Strategy**.

Typical depths for HDDs will be in the range of 5m - 10m. When cables are installed at a greater depth to maintain the rating of the cables it will be necessary to increase the cable spacing. Typically, the axial spacing between ducts will be in the range of 5m - 10m. The depth of the HDD will be dependent on the ground profile and the cable spacing will be dependent upon the cable ratings.

3.4.6 Maintenance of the Cables

Maintenance of the cables will comprise an inspection inside the link boxes, which will be located at every fifth jointing bay, every two years.

3.4.7 Decommissioning Cables on Land

The HVDC, HVAC and fibre optic cables will be decommissioned when Greenlink ceases operation, at the same time as decommissioning of the converter station and tail station. The current trend is to refurbish HVDC equipment at the end of its operational lifetime and extend the lifetime of the interconnector.

When it becomes appropriate to decommission the interconnector, the HVDC and HVAC cables will remain in-situ as there would be more environmental impact in removing the cables than can be justified by the recycle value of cable material. However, the link boxes and fibre optic joints will be removed, and their locations reinstated.

Section 2.8 of Chapter 2 *Alternatives Considered* provides further details on the various decommissioning options for the cables.

3.5 Tail Station

The HVAC cables will connect the existing Eirgrid Great Island substation to a small new substation, located adjacent to the proposed converter station. This new substation will be referred to as the 'Loughtown tail station'. The earthworks platform, on which the converter station will be built, will extend westwards to accommodate the tail station.

The Loughtown tail station, as illustrated in **Figure 3.16**, will have a footprint of 32m by 35m and will be approximately 11 metres height. The levelled platform for the tail station will be at the same elevation as the converter station platform. The tail station will have the same design life as the converter station.

The tail station has been designed to comply with EirGrid's specifications. The tail station will comprise a single 220kV gas insulated switchgear (GIS) circuit along with control panels and a small diesel generator (250kVA). It will have a single perimeter fence, 2.4m in height.

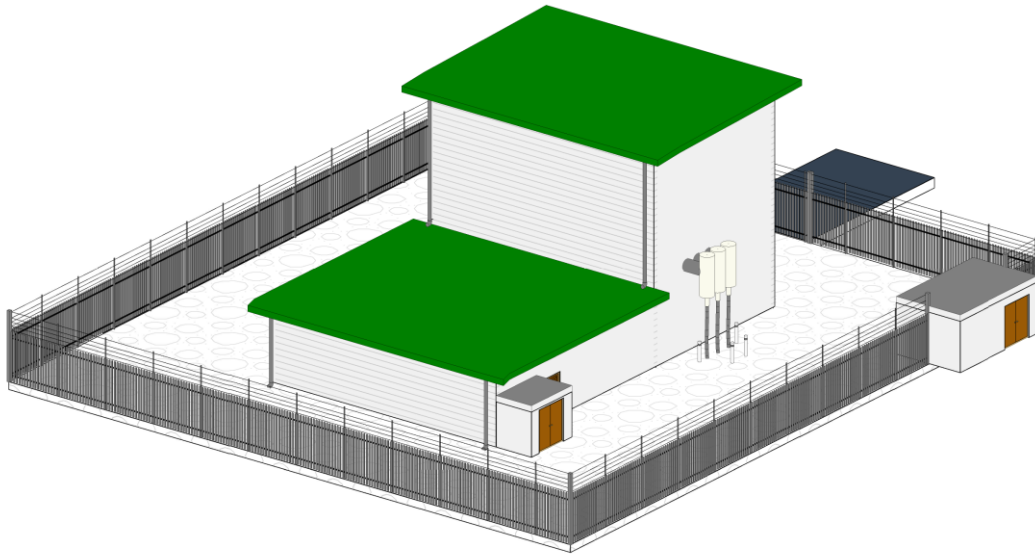

Figure 3.16: Tail Station 3-D View (source: WSP | not to scale)

3.6 Converter Station

3.6.1 Site Location and Context

The converter station site is located to the east of the SSE Great Island Power Station site, in County Wexford, see **Figure 3.2** for site location. Great Island Power Station operates subject to an Industrial Emissions licence, and is a lower-tier Control of Major Accidents Hazards (COMAH) site. The site is located to the north of the River Barrow Estuary and south of the disused Waterford to Rosslare Harbour railway line. The nearest village is Campile, approximately 3km to the east. New Ross is located circa 17km to the north. The site is accessed from local roads off the R733, which runs in a north-south direction, approximately 1km to the east of the site.

The converter station site is located within an area of pasture, within a single field. The site is circa 9.3ha (23acres) in area. The site is of low ecological interest. The site will be re-graded to form a level platform, at an elevation of 23mOD, for the converter station and tail station footprint.

3.6.2 Converter Station Buildings and Equipment

The area of the footprint of the proposed levelled platform for the converter station will be circa 1.85 hectares. This footprint will accommodate a 500MW nominal capacity station, for the conversion between HVAC and HVDC electrical currents. Within that footprint, two alternative converter station configurations are currently being considered by Greenlink Interconnector Ltd. The exact configuration will be chosen by the (one of two) contractor that will be awarded the design/build contract. Although the final configuration of the converter station has not yet been determined, the 'worst-case' environmental effects of the converter station alternatives has been documented and assessed in this EIAR.

The two converter station configurations and equipment will function in the same manner, and both will comply with strict guidelines when operating.

3.6.3 Alternative Configurations

As detailed in **Section 3.6.2**, two alternative converter station configurations will be submitted as part of the planning application.

The alternative converter station configurations are illustrated in **Figure 3.17** and **3.18**.

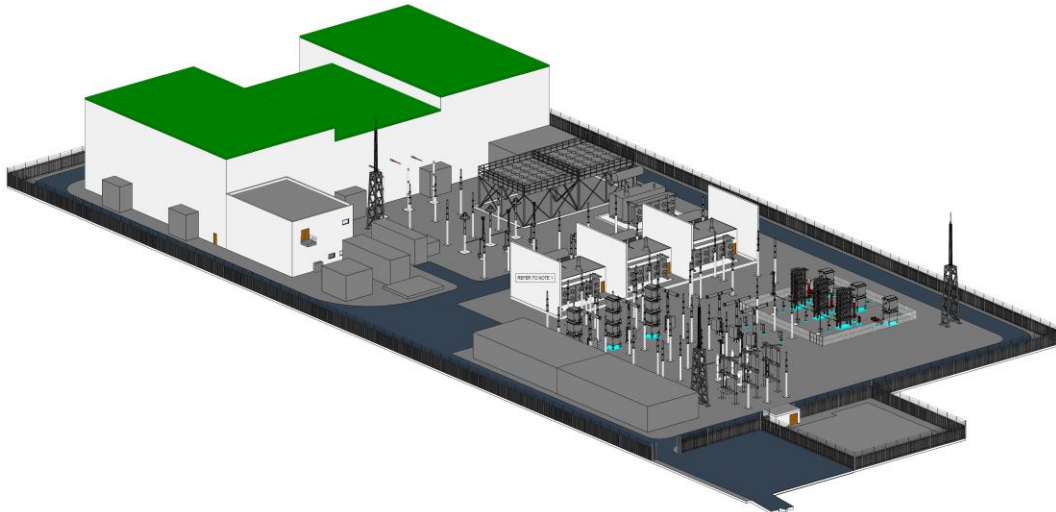

Figure 3.17 Converter Station Alternative Configuration 1 3-D View (source: WSP | not to scale)

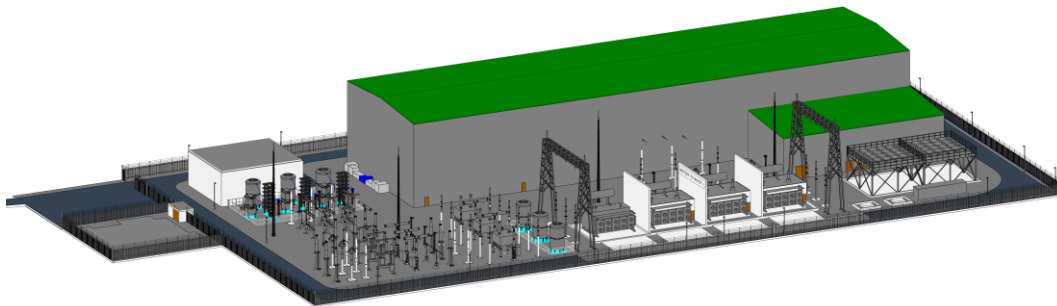

Figure 3.18 Converter Station Alternative Configuration 2 3-D View (source: WSP | not to scale)

The converter station will include various buildings, apparatus and equipment. These will include a converter hall, converter transformers, AC switchgear and busbars, harmonics filters, lighting towers, ancillary plant such as cooling bank and a diesel generator, and a control building. The tallest components will be the lighting towers at c. 26 metres high and the converter hall, which will be up to 21 metres high at its apex. The converter hall and main building will be one continuous building with roofs at different heights. Refer to **Figures 3.18** and **3.19**. A description of the main components of the converter station is presented below.

3.6.4 Converter Hall

The converter hall will house the valve, reactor and DC switches. The valve equipment will convert electrical power from DC to AC.

The DC switches will control the DC cable termination area. The reactors will be large air-cooled reactors.

The proposed building will be a rectangular (approximately 125m x 62m for Alternative 1), shallow pitch (typically 4° - 6°), single storey piled structure to provide a weather proof enclosure over the electrical plant, instrumentation and switchgear. Internally, the building will be divided into the reactor hall, valve hall and DC hall. Due to the building functionality and electrical clearance requirement, internal columns will be minimised. Furthermore, in addition to standard live and dead loads on the roof, the roof structure may include beams capable of lifting at least 10 tonnes of equipment and these beams would be integrated into the roof structure. To aid installation and removal of large equipment, lifting beams will be supported from the roof structure at appropriate positions.

Roof cladding will be standing seam roof cladding on cold formed purlins supported from primary roof beams.

Wall cladding will be an appropriate composite wall cladding on cold formed rails supported from primary steel columns. The cladding design will give the appearance of an 'ordinary' industrial building, with colours selected to minimise visual impacts (refer to **Chapter 11 Landscape and Visual**). The ground floor will be designed as suspended in-situ concrete piled raft to suit the design loading and usage requirement.

3.6.5 Control Building

The control room will accommodate equipment housed in panels which will provide the functionality of operation, control and protection of the converter station's electrical equipment.

The control building will comprise a single storey piled structure (approximately 45m x 18m) with a cable basement and a lightweight roof with no permanent access/access for maintenance only. Each floor will be divided by lightweight but durable metal stud partitions to provide dedicated spaces for batteries, panels, etc.

Welfare facilities will be provided in the control building.

The control building and converter halls will have a common superstructure and substructure due to their very close proximity.

The below ground cable basement will be designed as a fully reinforced retaining wall with appropriate penetrations to suit LV cables and valve cooling pipes. The perimeter retaining wall will be designed for an appropriate surcharge loading, for the permanent design condition. The retaining wall will be designed and constructed as a water retaining structure.

A composite roof cladding system suitable for 8° roof pitch on cold formed purlins supported from primary roof beams will be adopted.

Wall cladding will be of an appropriate composite on cold formed rails supported from primary steel columns, in colours selected to minimise visual impacts.

The basement floor slab will be designed as a suspended in-situ concrete piled raft to suit design loading and usage requirement.

3.6.6 Spare Parts Building/Storage Building

The spare parts building, labelled 'Storage building' on the alternative plan, will house the equipment that will be used to replace worn or faulty equipment (Alternative 1 has an area of 349m² and a height of 8.305m, while Alternative 2 has an area of 266m² and a height of 5.590m). Included within the spares building will be cable drums that will be used to replace damaged DC cable.

The spare parts building will be a duo pitched piled portal frame structure to suit the project requirements.

A composite roof cladding system suitable for 8° roof pitch on cold formed purlins supported from primary roof beams will be adopted.

Wall cladding will be an appropriate composite on cold formed rails supported from primary steel columns. The cladding design will be developed in such a way to give the appearance of an industrial building.

The ground floor will be designed as suspended in-situ concrete piled raft to suit the design loading and usage requirement.

3.6.7 Transformer and Bunds

Transformers will be sited within a reinforced concrete bund which will be linked to an underground oil dump tank.

The location of the converter transformers on site will be in accordance with fire design and electrical clearance requirement. 9.0m high precast fire walls with 4 hours fire resistance will be provided, where appropriate, to provide adequate separation between adjacent transformers and electrical circuits.

Transformer bunds will be designed as waterproof structures in accordance with BS EN 1992-3. The bunds will be tested in accordance with standard bund testing requirements.

The height of all oil retaining area walls will be a minimum of 450mm above the finished substation ground level or the support plinth(s) of the associated contacting equipment, whichever is greater, to provide a physical barrier preventing possible vehicular contact with transformers.

Rainwater or other surface water shall permeate through a flame trap. Once permeated through the stone fire trap, the water will be collected in a common dump tank. It will then be pumped out of the dump tank via a bund water control pump to a manhole, before flowing by gravity to a hydrocarbon interceptor prior to final discharge into the surface water drainage system.

The oily water system will incorporate penstocks to close off the system.

The hydrocarbon interceptor system will include a Class 1 full retention unit in accordance with BS EN 858-1, incorporating a coalescer automatic closure device and high oil level alarm. The separator shall be fully capable of isolating all upstream oil flow in the event that the high-level oil alarm is activated.

The interceptor will be sized to suit the storm intensity flow rates from the transformer bunds and any other designated oil containment area.

3.6.8 Storage of Liquids

The coolant, which will be either distilled water or glycol (depending on the contractor employed), will be the only liquid stored in bulk on site, apart for the fuel storage for the standby generator. Coolant will be stored in special standby tanks located in the cooler pump room. The cooler pump room will be adjacent to the Storage Building, or part of the control building.

3.6.9 Standby Generator

The standby generator, approximately 2000kVA in size, is self-contained with 2 days of fuel storage.

3.6.10 Landscaping

Within the converter station site that accommodates the converter station site and Loughtown tail station, a comprehensive landscaping scheme will be implemented, incorporating significant earthworks, berming, planting of approximately 15,000 native mixed-woodland trees, and zones of grassland meadow. Refer to **Chapter 11 Landscape and Visual** for further details of the landscaping plan for the converter station site.

3.6.11 Utility Connections

The converter station and tail station will have the following utility connections:

- Potable Water;
- Foul Drainage;
- Surface Water Drainage;
- Telecoms and IT; and
- Electricity.

3.6.11.1 Potable Water

Potable water for the site will be provided by a new watermain, which will connect to the existing watermain just outside the site and will be laid along the proposed site access road, to the welfare facilities in the control building of the converter station and in the tail station.

3.6.11.2 Foul Drainage

There will be two personnel stationed at the converter station at all times operating the interconnector, with only infrequent visits by personnel to the tail station. Therefore, foul wastewater generated will be minimal. Foul wastewater will be collected from the welfare facilities in the converter station and tail station.

It will be contained in the units and removed from site periodically, by a licensed service provider, to a local sewage treatment plant, which has adequate capacity.

3.6.11.3 Surface Water Drainage

Surface water on site will be collected in a new surface water drainage system as detailed on Drawings C-CS-010 and C-CS-011 (included in the planning application drawings). Surface water from the proposed access road will connect to the existing Great Island sub-station road drainage.

Surface water run-off from yard areas and the building roofs of the converter station and tail station, will discharge through proposed filter drains and surface water sewers, through a bypass interceptor, to a proposed attenuation pond, to be constructed to the southeastern part of the site. The attenuation pond is shown on Drawing C-CS-010 and C-CS-011 and will provide c. 800 m³ of storage. The attenuation pond will have a c. 1.5 m track around its perimeter and will be excavated to provide 1 in 3 side slopes. Discharges from the attenuation pond will be via an outfall pipe to the existing stream in the eastern part of the site (Newtown Stream) and will be controlled to greenfield rates, as shown on the drawings.

3.6.11.4 Telecoms and Electrical Supply

New connections will also be provided to the converter station and tail station for telecoms and electrical supply, from existing utility services adjacent to the site.

The 10kV electrical connection will be made by underground cable, routed northwards from the low voltage substation, which is located to the northeast of the 220kV Eirgrid substation, as far as the main access road, and then eastwards to the converter station site.

The telecoms connection will be an underground connection route along the converter station and tail station access road to the Eircom service on the public road at the entrance to the SSE power station site.

3.6.12 Security Fencing

Two security fences, one inside the other, will be installed around the perimeter of the Converter Station, with access through security gates. The fences are likely to be as follows:

- A 2.4m high security weld mesh fence, with perimeter gates for vehicular and pedestrian access
- A 3.4m high power fence (electrified).

CCTV cameras will be installed along the perimeter for security purposes and will be monitored remotely. Intruder alarms will be signalled to the remote monitoring at the Greenlink Operations facility.

3.6.13 External Lighting

The lighting system will provide adequate illumination within the converter station to allow personnel to move without risk to health and safety. Security lighting will be installed against the building and GRP lighting poles of at least 6m height will be installed for illuminating the external area between buildings, transformer and reactor area and within the perimeter walls.

Under normal operating conditions, external lighting would be switched off during the hours of darkness, to avoid creating any unnecessary glare in the night sky. The exception would be for emergency repairs to outdoor equipment, where high-level illumination would be switched on. The use of motion sensor technology is likely to be implemented to control lighting at access doors, security gates, etc.

3.6.14 Site Access Road and Site Surfacing

A new access road, to provide access and egress from the site, will also be provided. This access road will connect to the existing Great Island Substation road.

Site surfacing (other than site access roads) will consist of clean, hard 30mm natural gravel or crushed stone to a compacted thickness of 150mm and lightly rolled. Site surfacing shall be spread after installation of services and cables. Filter drains, connected to the surface water drainage system, described above, will collect surface water run-off from the site road and yard areas.

3.6.15 Operation and Maintenance of the Converter Station

Greenlink is anticipated to provide permanent employment for approximately 20 people for the overall project in Ireland. Of this figure approximately five people will have particular responsibility for the proposed development during the operational phase. Of these five, two personnel will be stationed at the converter station at all times operating the interconnector.

It is expected that one or two vehicles may attend the site every four weeks for an inspection. Each inspection will be limited to approximately four hours and restricted to within normal working hours.

On an annual basis, four consecutive days each year, the converter station will undergo maintenance work that will typically require 12 to 15 vehicles per day. This work may be undertaken on a shift pattern to allow 24-hour working.

For powering the auxiliary systems of the converter station there are two alternative power supplies. There will be a 10kV supply from the local distribution network and a standby generator, that will be available for operation in the event the normal auxiliary supply is lost. The standby generator will likely be one 2MVA unit housed in a weatherproof enclosure and

located upon a concrete bund. Since the latter is a secondary reserve, use will be limited to testing; circa one day per annum.

3.6.16 Operation and Maintenance of the Tail Station

Eirgrid will operate the tail station. The station will operate continuously. It will be unmanned and operated remotely. Eirgrid staff will visit infrequently to inspect equipment. The tail station will be subject to an annual maintenance visit of several days duration by a small crew.

3.6.17 Decommissioning the Converter Station and Tail Station

The converter station and tail station will be decommissioned when Greenlink ceases operation. The design life of these assets will be 40 years. The current trend is to refurbish HVDC equipment at the end of its operational lifetime and extend the lifetime of the interconnector.

When it becomes appropriate to decommission the interconnector, each item of equipment in the converter station and tail station will be removed for appropriate management, based on the waste regulations at the time of decommissioning. All above ground structures within the proposed converter station and tail station footprint will be removed and the site will be returned to its previous state. It is not proposed to remove landscaping berms and planting. The attenuation pond will be filled in with some subsoil from the original site works, used to form the landscape berm, and then top-soiled.

3.7 Community Gain (also summarised in Appendix 3.1)

3.7.1 Car Park at Baginbun Beach

Baginbun Beach is popular with locals and tourists, especially during the summer months. Currently, visitors to the beach park along both sides of the narrow approach road to the beach and, at particularly busy times, the parking extends around the corner onto the L4049, at the western end of the approach road. This parking creates congestion and is a hazard for road users, particularly pedestrians.

During the consultations with Wexford County Council, Greenlink agreed to construct car-parking facilities near Baginbun Beach as an element of community gain for the project. Greenlink will purchase a strip of land on the north side of the approach road which will allow the road to be widened to an overall width of 12m. The road is edged with low scrub, which does not have high habitat value. There will be a 3m wide parking bay on both sides and two 3m wide vehicular lanes. Approximately 54 parking spaces will be provided, with parallel parking along both sides of the road. The 6m wide carriageway will allow two cars to pass comfortably. The road widening will extend from the junction at the western end of the road to a point approximately 35m west of the edge of the cliff, behind the beach. A 10kV ESB pole, close to the junction at the western end of the road, will be relocated to accommodate the road

widening. There are two farm gates in the road boundaries, one on either side. The gate on the northern side will be set back as part of the widening, and appropriate sight lines will be provided for both gates.

There is an entrance to a dwelling house close to the beach, on the southern side of the road, and this will also be given sufficient sight lines. A turning area will be established at the beach end of the road. The 6m wide carriageway will also facilitate three-point turning along the road. The widened road and parking will be constructed with a full road build-up, surface dressing and line markings, with stormwater run-off continuing to naturally infiltrate on both sides of the road in accordance with Wexford County Council's requirements.

Figure 3.19. illustrates the proposed roadside car parking area.

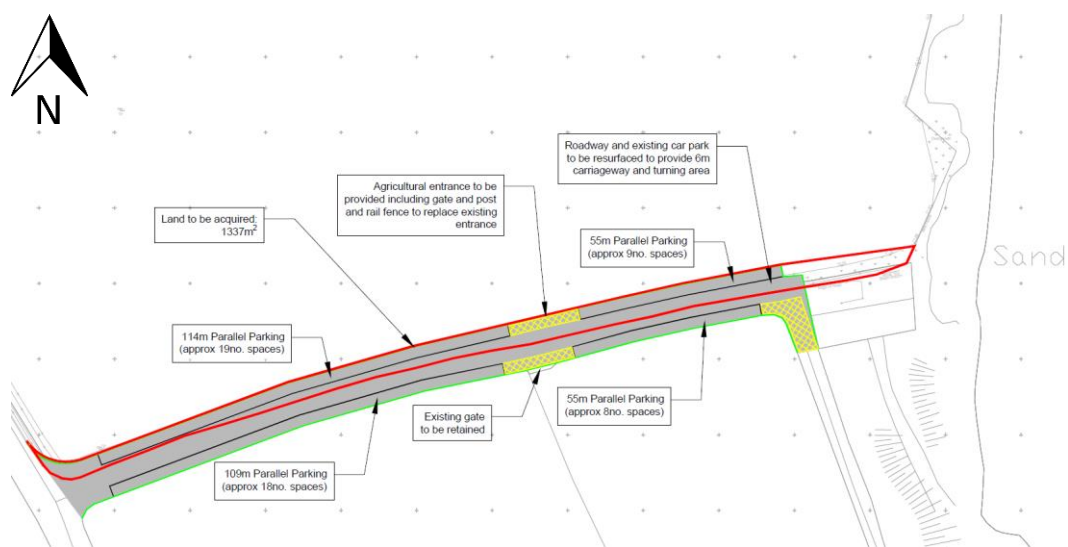

Figure 3.19: Proposed Car Parking near Baginbun Beach | not to scale

This parking facility is welcomed by Wexford County Council and the local residents, to whom the Greenlink representatives have spoken.

The car park at Baginbun Beach will be retained when Greenlink is decommissioned.

3.7.2 Ramsgrange Village

As part of the public engagement with residents in Ramsgrange, the potential was identified for the provision of community gain in the form of improvements to pedestrian amenity in the village. In consultation with Wexford County Council, it was agreed that a footpath would be provided on the southern side of the R733 eastbound, between the village centre and the recently-constructed housing development at the eastern edge of the village. In addition, a short length of footpath will be provided on the northern side of the road, opposite the housing development. The new footpaths will generally be a minimum of 1.8 metres wide, and dropped kerbs will be provided at each entrance.

Four new street lights will be provided on the northern side of the road, to the east of the existing school entrance, and a new speed-activated sign will be

provided at the western approach to the village. Surface water drainage will be connected to the existing surface water network, and a power cable will be installed to power the proposed street lighting.

Figure 3.20 illustrates the proposed works at Ramsgrange.

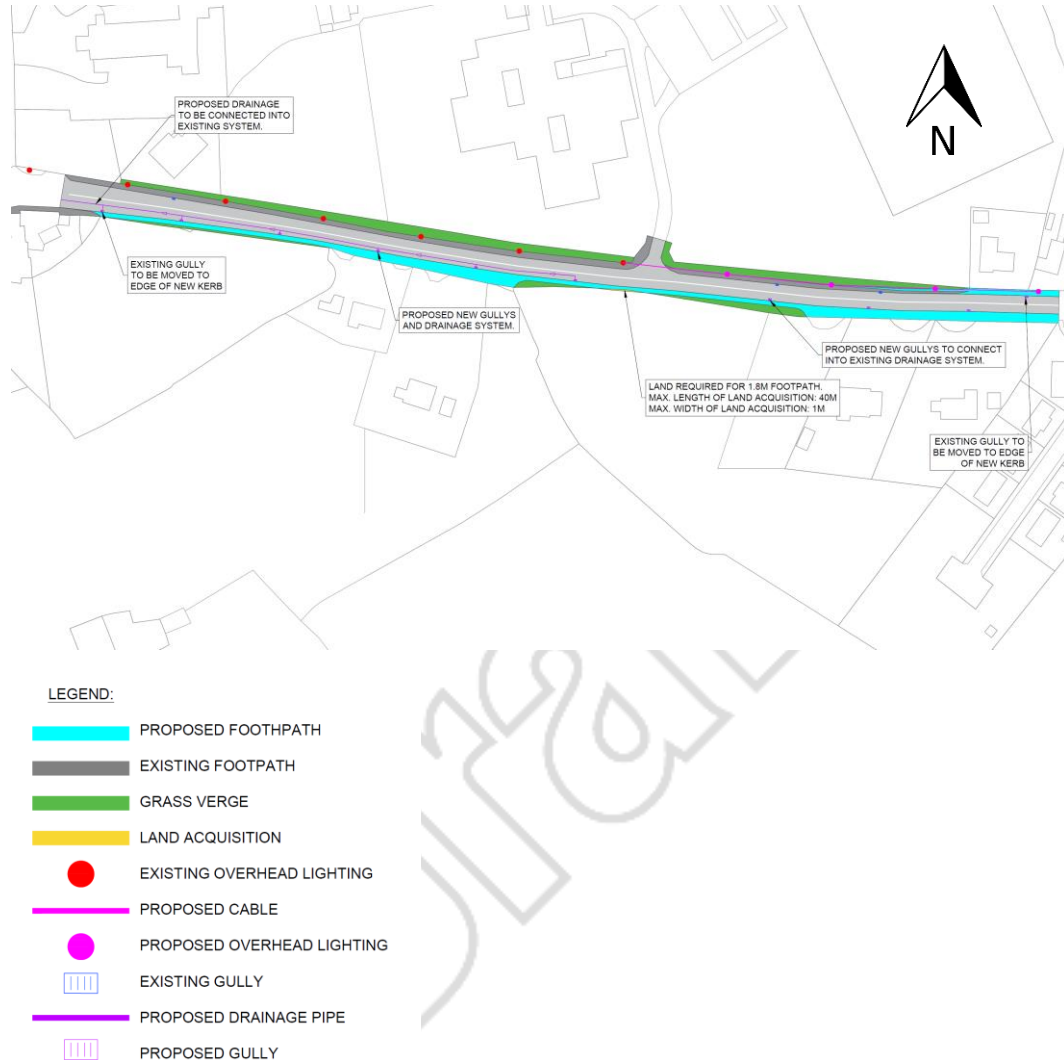

Figure 3.20: Proposed Pedestrian Amenity Improvement Works at Ramsgrange | not to scale

3.8 Other Parts of the Project

As explained in **Chapter 1**, the overall Greenlink project is a proposed subsea and underground electricity interconnector between the existing electricity grids in Ireland and Great Britain, with a nominal capacity of 500 MW.

A brief description of the other elements of the project is provided below. **Figure 3.20** illustrates the main components of the overall project.

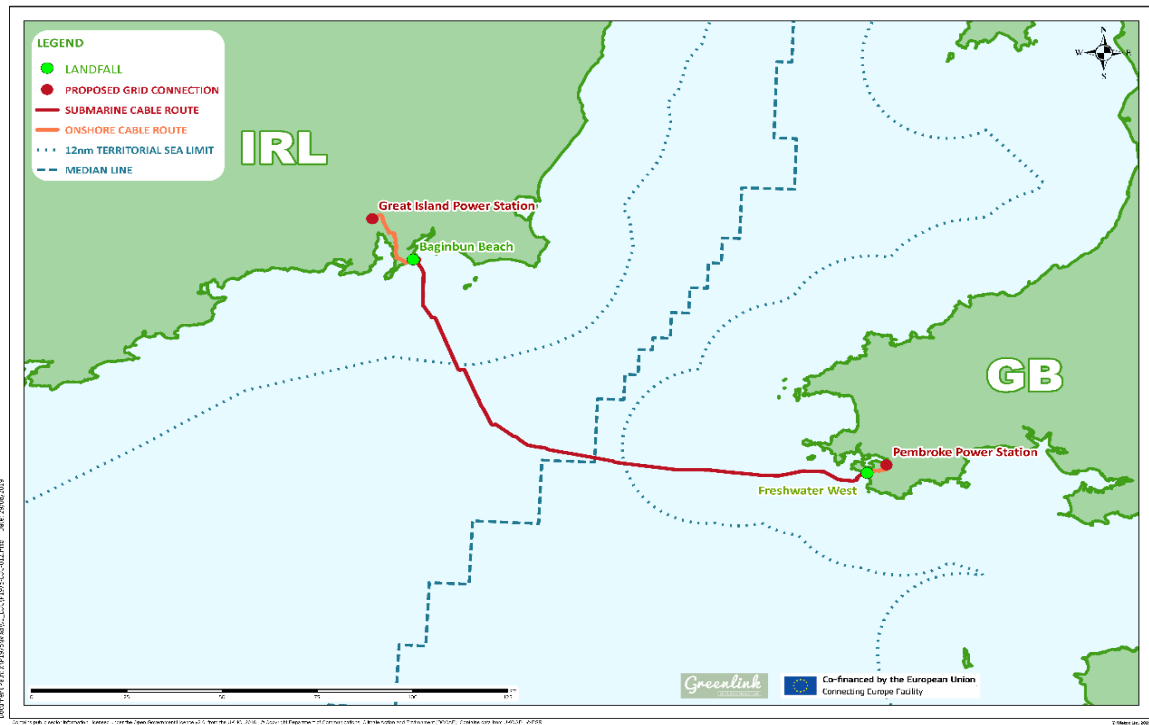

Figure 3.20: Greenlink Overview | not to scale

3.8.1 Subsea Cable (Ireland to Wales)

From the landfall at Baginbun beach in Ireland, the marine cables will follow the offshore cable route, as illustrated in Figure 3.20, to the landfall site in South Wales, at Freshwater West, Pembrokeshire.

The chosen route was informed by subsea surveys undertaken in 2018/19 and offers the best solution to challenges identified while maintaining the shorted route solution. The subsea route is approximately 160km long; circa 86km in Irish waters and 74km in Welsh waters. In Irish waters, approximately 36km is within the foreshore area, Irish territorial waters out to the 12 nautical mile limit, with approximately 50km in the Irish Exclusive Economic Zone (EEZ). In Welsh waters, approximately 66km is within Welsh territorial waters, with approximately 8km in the Welsh offshore area.

A 500m wide corridor for the cable is being included in the consent applications for the offshore cable, although the final cable configuration will only be in the order of 10m to 20m wide. This flexibility allows for micro-routing and optimisation of the final laid submarine cables, to minimise engineering and environmental challenges.

The marine cables will be tied together in a bundle with a fibre optic cable (used for control and communications purposes) and laid in a single trench. The target depth of burial of the cables will be 1.0m for all areas of loose sediment (sands/gravels) and 0.6m for areas of glacial till along the route. The depths of burial of the cables have been chosen to mitigate the risk of damage from ships anchoring or fishing activities.

The nature of the seabed varies along the cable route, ranging from fine sediments to stony reefs, consisting of pebbles and boulders and bedrock outcrops. Burial in the seabed is the preferred option, but where the seabed composition is not suitable for burial, external mechanical protection will be provided through rock placement or concrete mattresses. Subsea surveys have indicated that burial in sediment is achievable for approximately 89% of the route.

Approximately 16km of the subsea cable route in Welsh waters will require external cable protection due to seabed conditions. External cable protection will also be used where Greenlink crosses existing subsea telecommunication cables in both Irish and Welsh waters.

As described in **Section 3.4.5** above, the marine HVDC cable will be connected to the terrestrial HVDC cable in an underground transition jointing pit (TJP). In Wales, the TJP will be sited within farmland, close to the beach at Freshwater West in Wales, with HDD being used to install ducts from the TJP to emerge below the low water mark. The ducts will pass approximately 10m beneath the beach at Freshwater West. The marine cables will then be pulled through the ducts to be jointed to the terrestrial HVDC cables. Further details of HDD construction is included in **Chapter 4 Construction Strategy**. All cabling and jointing infrastructure would be below ground and following completion of the HDD and jointing activities, the landfall compound will be reinstated and returned to arable use. The use of HDD will avoid damaging sensitive ecological features such as the dune system at Freshwater West.

Greenlink crosses one out-of-service telecoms cable within Irish territorial waters, and a further four in-service telecoms cables within the Irish EEZ. The in-service cables will be crossed on a 'bridge' comprised of aggregate (rock) and concrete mattresses.

3.8.2 Onshore Infrastructure in Wales

The onshore infrastructure in Wales is similar to that in Ireland, as described herein. In Wales, the National Grid Pembroke substation was identified as the connection point for Greenlink. HVAC cables will connect the Greenlink converter station to this substation.

The HVDC onshore cable route in Wales will be approximately 7km long, from the landfall at Freshwater West to the proposed converter station site. The cable route, as indicated in **Figure 3.20** is generally routed through agricultural land and the existing road network.

From the landfall, the cable will be laid northwards through the agricultural field boundary towards the B4320 road. HDD will be employed to install the HVDC cable under the B420 to an exit point outside the boundaries of the Limestone Coast of South Wales SAC and the Broomhill Burrows Site of Special Scientific Interest and a sensitive treeline.

The HVDC cable will continue underground eastwards in agricultural (pastoral and arable) fields outside the protected sites, continuing eastwards through farmland before turning northwards beyond a water supply pond.

The cable route continues north, through a short section of woodland, before re-emerging into farmland and merging with the unnamed road linking Wallaston Cross and Angle Bay.

The cable will then be installed within this road, progressing eastwards to Wallaston Cross, before continuing eastwards to the converter station site near Lambeeth Farm. The converter station will be contained within a single field with HVDC cables entering at the south and HVAC cables emerging to the north. The converter station will be similar to that for the Great Island Converter station described herein in **Section 3.6**.

The HVAC cable route will emerge from the converter station site within a hedgerow gap on the northern field boundary, before following further gaps in hedgerows and treelines north and east to avoid existing infrastructure, crossing the Wales Coast Path, before continuing north to connect at the National Grid substation.

3.9 Unrelated Projects which have the Potential for Cumulative Effects

Two permitted projects have been identified which have the potential to give rise to cumulative effects with the Greenlink proposed development.

- Eirgrid Great Island - Kilkenny 110kV Line Uprate Project
- Great Island Energy Storage System

These projects, which have received planning permission, are described in **Chapter 18, Cumulative, Transboundary and Interactive Effects**.

3.10 References

Greenlink Interconnector Limited (2019) *Greenlink Marine Environmental Impact Assessment Report - Ireland*

Greenlink Interconnector Limited (2019) *Greenlink Marine Environmental Statement - Wales*

Greenlink Interconnector Limited (2020) *Greenlink [Onshore Wales] - Environmental Statement*